

MINIATURE CIRCUIT BREAKERS

ST 200 M data sheet

System pro M compact® miniature circuit breakers for supplementary protection acc. to UL 1077

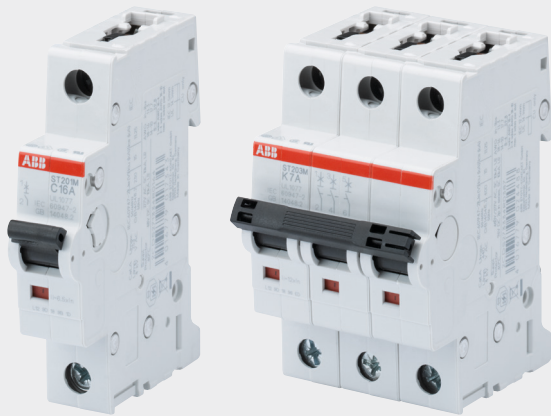

The ST 200 M miniature circuit breaker provides supplementary protection acc. to UL 1077 up to 480 Y/277 V AC and 125 V DC. With a broad range of options and approvals acc. to the international standards UL, CSA and IEC, the ST 200 M is ideal for multiple applications and markets. It is also fully compatible with System pro M compact® accessories.

Features

- High performance MCB with interrupt rating up to 10 kA
- Certified for AC and DC use acc. to UL 1077 and CSA 22.2 No. 235
- Suitable for many applications due to a wide range of product types and available accessories
- High calibration temperature of 40 °C for reduced derating in ICP applications
- Short-circuit current rating (SC) U2 enables continuous high level short circuit protection
- Laser printing provides clear product information on device
- Clear contact position indication in red/green (“real CPI”)
- Unique, patented twin terminal for wiring up to 35 mm² with captive screws
- Field wiring available for most types
- Robust thermoplastic housing material for better protection against external influences

Standards and approvals

Standards

UL 1077
 CSA 22.2 No. 235
 IEC/EN 60947-2

Approvals

UL 1077	US
CSA 22.2 No. 235	CA
VDE	DE
CCC	CN
EAC	RU

Miniature Circuit Breaker ST 200 M

Technical data

1) 2P/3P/4P single pole load: TC2

2) for 1P, 1P+N, 2P, 3P

General Data	
Standards	IEC/EN 60947-2, UL 1077, CSA 22.2 No. 235
Poles	1P, 2P, 3P, 4P, 1P+N, 3P+N
Tripping characteristics	B, C, D, K, Z
Rated current I_n	0.5...63 A
Rated frequency f	50 / 60 Hz
Rated insulation voltage U_i acc. to IEC/EN 60664-1	440 V AC
Overvoltage category	III
Pollution degree	3
Data acc. to IEC/EN 60947-2	
Rated operational voltage U_e	1P, 1P+N: 230 V AC 2P, 3P, 3P+N, 4P: 400 V AC
Highest supply or utilization voltage acc. to IEC 60038 (U_{max})	1P, 1P+N: 253 V AC 2P, 3P, 3P+N, 4P: 440 V AC 1P: 60 V DC; 2P: 125 V DC
Min. operating voltage	12 V AC, 12 V DC
Rated ultimate short-circuit breaking capacity I_{cu}	15 kA
Rated service short-circuit breaking capacity I_{cs}	≤ 40 A: 11.25 kA > 40 A: 7.5 kA
Rated impulse withstand voltage U_{imp} . (1.2/50 μs)	4 kV (test voltage 6.2 kV at sea level, 5 kV at 2,000 m)
Dielectric test voltage	2 kV (50 / 60Hz, 1 min.)
Reference temperature for tripping characteristics	30°C
Electrical endurance	$I_n < 30$ A: 20,000 ops (AC), $I_n ≥ 30$ A: 10,000 ops. (AC); 1,000 ops. (DC); 1 cycle (2s - ON, 28s - OFF)
Data acc. to UL / CSA	
Rated voltage	1P, 1P+N: 277 V AC; 240 V AC 2P, 3P, 3P+N, 4P: 480Y / 277 V AC; 240 V AC 1P: 60 V DC; 2P (in series): 125 V DC
Rated interrupting capacity acc. to UL 1077	480Y / 277 V AC: ≤ 32A: 10 kA; > 32A: 5 kA; 240 V AC: 10 kA 60 / 125 V DC: 0.5...63A: 10 kA
Short-circuit current rating acc. to UL 489	-
Application	Suppl. Protector for general use; application codes: TC1 ¹⁾ , OLO, SC: U2 (AC), SC: U2 (DC), FW3 ²⁾
Reference temperature for tripping characteristics	40 °C
Electrical endurance	6,000 ops (AC), 6,000 ops. (DC); 1 cycle (1s - ON, 9s - OFF)
Mechanical Data	
Housing	Insulation group II, RAL 7035
Toggle	Insulation group II, black, sealable
Contact position indication	CPI (red ON / green OFF)
Protection degree acc. to EN 60529	IP20, IP40 in enclosure with cover
Mechanical endurance	20,000 ops.
Shock resistance acc. to IEC/EN 60068-2-27	25 g - 2 shocks - 13 ms
Vibration resistance acc. to IEC/EN 60068-2-6	5g - 20 cycles at 5...150...5 Hz with load 0.8 I_n
Environmental conditions (damp heat) acc. to IEC/EN 60068-2-30	28 cycles with 55°C/90-96% and 25°C/95-100%
Ambient temperature	-25 ... +55 °C
Storage temperature	-40 ... +70 °C
Installation	
Terminal	Failsafe bi-directional cylinder-lift terminal
Cross-section of conductors (top / bottom) Solid, Stranded	35 mm ² / 35 mm ²
Flexible	25 mm ² / 25 mm ² 18 - 4 AWG
Cross-section of busbars (top / bottom)	10 mm ² / 10 mm ² 14 - 8 AWG
Tightening Torque	2.8 Nm AWG 18-16: 8.85 in-lbs. AWG 14-10: 17.7 in-lbs. AWG 8-4: 39.8 in-lbs.
Screwdriver	No. 2 Pozidrive
Mounting	On DIN rail 35 mm acc. to EN 60715 by fast clip
Mounting position	any
Supply	optional
Dimensions and weight	
Mounting dimensions acc. to DIN 43880	Mounting dimension 1
Pole dimensions (H x D x W)	88 x 69 x 17.5 mm
Pole weight	approx. 115 g
Combination with aux. elements	
Auxiliary contact	Yes
Signal contact	Yes
Shunt trip	Yes

Miniature Circuit Breaker ST 200 M

Tripping characteristics

1) The thermal releases are calibrated to a nominal reference ambient temperature e.g. for UL 1077 of 40 °C. In the case of higher ambient temperatures, the current values fall by approx. 4 % for each 10 K temperature rise.

2) The indicated tripping values of electromagnetic tripping devices apply to a frequency of 50/60 Hz. The thermal release operates independent of frequency.

3) As from operating temperature (after $I_1 > 1h$)

Tripping characteristics

Acc. to	Tripping characteristics	Rated current I_n	Thermal release ¹⁾ Currents:		Tripping time	Electromagnetic release ²⁾	
			conventional non-tripping current I_1	conventional tripping current I_2		Range of instantaneous tripping	Tripping time
UL 1077	B	0.5 to 63 A	$1.03 \cdot I_n$	$1.25 \cdot I_n$	$> 1 h$	$3 \cdot I_n$	$> 0.2 s$
	C	0.5 to 63 A	$1.03 \cdot I_n$	$1.25 \cdot I_n$	$> 1 h$	$5 \cdot I_n$	$> 0.2 s$
	D	0.5 to 63 A	$1.03 \cdot I_n$	$1.25 \cdot I_n$	$> 1 h$	$10 \cdot I_n$	$> 0.2 s$
	K	0.5 to 63 A	$1.03 \cdot I_n$	$1.25 \cdot I_n$	$> 1 h$	$10 \cdot I_n$	$> 0.2 s$
	Z	0.5 to 63 A	$1.03 \cdot I_n$	$1.25 \cdot I_n$	$> 1 h$	$2 \cdot I_n$	$> 0.2 s$

B characteristic

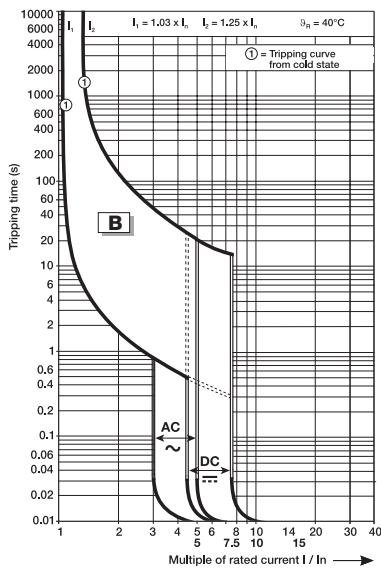

C characteristic

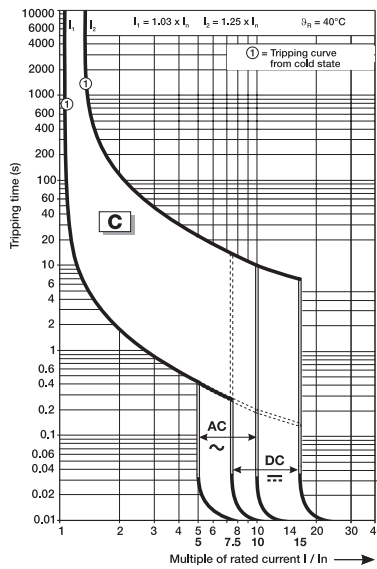

D characteristic

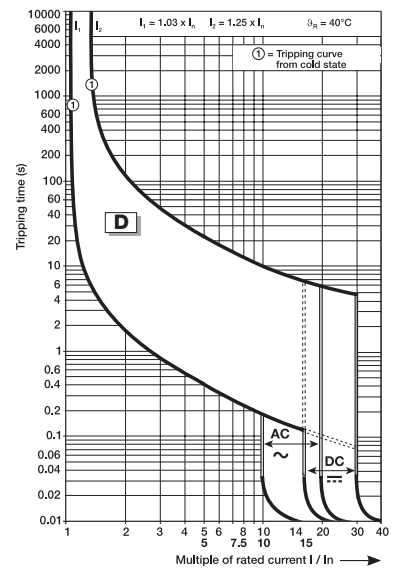

K characteristic

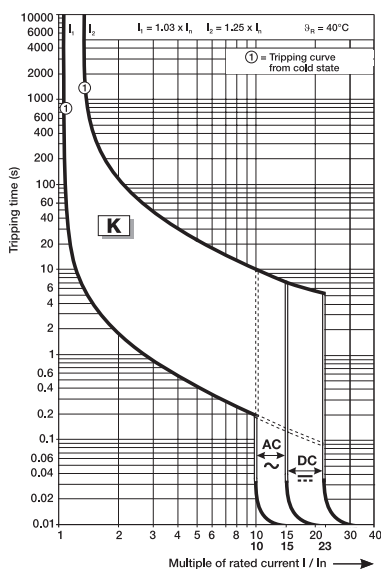

Z characteristic

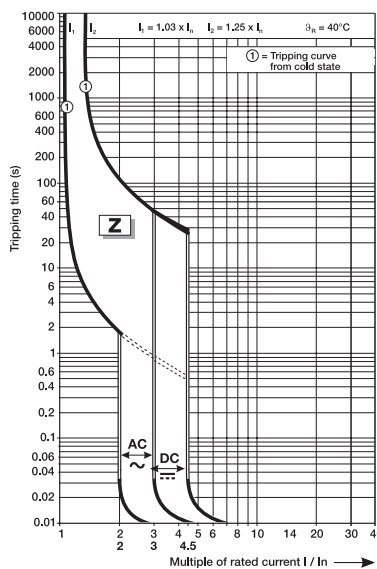

Miniature Circuit Breaker ST 200 M Derating

Deviating ambient temperature

The rated value of the current of a miniature circuit breaker of ST 200 M series refers to a reference ambient temperature of 30 °C acc. to IEC/EN 60947-2

and 40 °C acc. to UL/CSA. The following tables show derating factors for ambient temperature from -40 °C to 70 °C for the characteristics B, C, D, K, Z.

IEC derating

Reference temp: 30 °C

IEC/EN 60947-2	ambient temperature (°C)											
$I_n(A)$	-40	-30	-20	-10	0	10	20	30	40	50	60	70
0.5	0.63	0.61	0.59	0.57	0.56	0.54	0.52	0.50	0.48	0.46	0.44	0.43
1	1.26	1.22	1.19	1.15	1.11	1.07	1.04	1.00	0.96	0.93	0.89	0.85
1.6	2.01	1.96	1.90	1.84	1.78	1.72	1.66	1.60	1.54	1.48	1.42	1.36
2	2.52	2.44	2.37	2.30	2.22	2.15	2.07	2.00	1.93	1.85	1.78	1.70
3	3.78	3.67	3.56	3.44	3.33	3.22	3.11	3.00	2.89	2.78	2.67	2.56
4	5.04	4.89	4.74	4.59	4.44	4.30	4.15	4.00	3.85	3.70	3.56	3.41
5	6.31	6.13	5.94	5.75	5.56	5.38	5.19	5.00	4.81	4.63	4.44	4.25
6	7.55	7.33	7.11	6.89	6.67	6.44	6.22	6.00	5.78	5.56	5.33	5.11
7	8.84	8.58	8.31	8.05	7.79	7.53	7.26	7.00	6.74	6.48	6.21	5.95
8	10.07	9.78	9.48	9.18	8.89	8.59	8.30	8.00	7.70	7.41	7.11	6.82
10	12.60	12.20	11.90	11.50	11.10	10.70	10.40	10.00	9.60	9.30	8.90	8.50
13	16.40	15.90	15.40	14.90	14.40	14.00	13.50	13.00	12.50	12.00	11.60	11.10
15	18.94	18.38	17.81	17.25	16.69	16.13	15.56	15.00	14.44	13.88	13.31	12.75
16	20.10	19.60	19.00	18.40	17.80	17.20	16.60	16.00	15.40	14.80	14.20	13.60
20	25.20	24.40	23.70	23.00	22.20	21.50	20.70	20.00	19.30	18.50	17.80	17.00
25	31.50	30.60	29.60	28.70	27.80	26.90	25.90	25.00	24.10	23.20	22.20	21.30
30	37.88	36.75	35.63	34.50	33.38	32.25	31.13	30.00	28.88	27.75	26.63	25.50
32	40.30	39.10	37.90	36.70	35.60	34.40	33.20	32.00	30.80	29.60	28.40	27.30
35	45.30	43.70	42.10	40.60	39.10	37.70	36.30	35.00	33.70	32.50	31.30	30.20
40	50.40	48.90	47.40	45.90	44.40	43.00	41.50	40.00	38.50	37.00	35.60	34.10
50	63.00	61.10	59.30	57.40	55.60	53.70	51.90	50.00	48.20	46.30	44.50	42.60
60	77.60	74.80	72.10	69.50	67.00	64.60	62.30	60.00	57.80	55.70	53.70	51.80
63	79.30	77.00	74.70	72.30	70.00	67.70	65.30	63.00	60.70	58.30	56.00	53.70

UL derating

Reference temp: 40 °C

UL 1077	ambient temperature (°C)											
$I_n(A)$	-40	-30	-20	-10	0	10	20	30	40	50	60	70
0.5	0.65	0.63	0.61	0.59	0.57	0.56	0.54	0.52	0.50	0.48	0.46	0.44
1	1.30	1.26	1.22	1.19	1.15	1.11	1.07	1.04	1.00	0.96	0.93	0.89
1.6	2.06	2.01	1.96	1.90	1.84	1.78	1.72	1.66	1.60	1.54	1.48	1.42
2	2.60	2.52	2.44	2.37	2.30	2.22	2.15	2.07	2.00	1.93	1.85	1.78
3	3.89	3.78	3.67	3.56	3.44	3.33	3.22	3.11	3.00	2.89	2.78	2.67
4	5.19	5.04	4.89	4.74	4.59	4.44	4.30	4.15	4.00	3.85	3.70	3.56
5	6.50	6.31	6.13	5.94	5.75	5.56	5.38	5.00	5.00	4.81	4.63	4.44
6	7.77	7.55	7.33	7.11	6.89	6.67	6.44	6.22	6.00	5.78	5.56	5.33
7	9.10	8.84	8.58	8.31	8.05	7.79	7.53	7.00	7.00	6.74	6.48	6.21
8	10.36	10.07	9.78	9.48	9.18	8.89	8.59	8.30	8.00	7.70	7.41	7.11
10	13.00	12.60	12.20	11.90	11.50	11.10	10.70	10.40	10.00	9.60	9.30	8.90
13	16.90	16.40	15.90	15.40	14.90	14.40	14.00	13.50	13.00	12.50	12.00	11.60
15	19.50	18.94	18.38	17.81	17.25	16.69	16.13	16.00	15.00	14.44	13.88	13.31
16	20.60	20.10	19.60	19.00	18.40	17.80	17.20	16.60	16.00	15.40	14.80	14.20
20	26.00	25.20	24.40	23.70	23.00	22.20	21.50	20.70	20.00	19.30	18.50	17.80
25	32.40	31.50	30.60	29.60	28.70	27.80	26.90	25.90	25.00	24.10	23.20	22.20
30	39.00	37.88	36.75	35.63	34.50	33.38	32.25	31.00	30.00	28.88	27.75	26.63
32	41.50	40.30	39.10	37.90	36.70	35.60	34.40	33.20	32.00	30.80	29.60	28.40
35	47.00	45.30	43.70	42.10	40.60	39.10	37.70	36.30	35.00	33.70	32.50	31.30
40	51.90	50.40	48.90	47.40	45.90	44.40	43.00	41.50	40.00	38.50	37.00	35.60
50	64.90	63.00	61.10	59.30	57.40	55.60	53.70	51.90	50.00	48.20	46.30	44.50
60	80.50	77.60	74.80	72.10	69.50	67.00	64.60	62.30	60.00	57.80	55.70	53.70
63	81.60	79.30	77.00	74.70	72.30	70.00	67.70	65.30	63.00	60.70	58.30	56.00

Miniature Circuit Breaker ST 200 M Derating

Influence of adjacent devices, internal resistance and power loss

Influence of adjacent devices

If several miniature circuit breakers are installed directly side by side with high load on all poles, a correction factor has to be applied to the rated current (see table). If distance pieces are used, the factor is not to be considered.

No. of adjacent devices	Factor F
1	1
2, 3	0.9
4, 5	0.8
≥ 6	0.75

Internal resistance and power loss per pole

Rated current I_n [A]	B. C. K		D		Z	
	Internal resistance per pole R_i [mOhm]	Power loss P_v [W]	Internal resistance per pole R_i	Power loss P_v	Internal resistance per pole R_i	Power loss P_v
0.5	5500	1.4	4300	1.1	8100	2.4
1	1440	1.4	1250	1.25	2100	2.3
1.6	645	1.8	600	1.5	1000	2.8
2	460	1.8	410	1.7	620	2.5
3	150	1.6	130	1.2	235	2.4
4	110	1.8	105	1.7	150	2.4
5	55	1.4	52	1.3	75	1.9
6	55	2.0	52	1.9	75	3.2
7	24	1.2	26	1.3	28	1.4
8	23	1.5	24	1.5	27	2.0
10	21	2.2	16	1.6	24	2.7
13	14	2.3	14	2.2	15	2.6
15	8.5	2	8.5	2	11	2.5
16	8.5	2.5	8.5	2.5	10.9	2.8
20	6.25	2.5	6.1	2.3	6.0	2.4
25	5.0	3.2	4.3	3.1	4.5	3.3
30	3.5	3.1	3.5	3.2	3.5	3.2
32	3.5	3.7	3.5	3.6	3.5	3.6
35	3.4	4.2	3.4	4.2	3.5	4.3
40	3.0	4.8	2.2	4.2	2.5	4.1
50	1.8	4.3	1.3	2.9	1.5	4.1
60	1.2	4.4	1.2	4.4	1.3	4.7
63	1.2	5.5	1.2	4.8	1.3	5.2

Internal resistances are subject to application-specific and environment-specific conditions and are therefore to be considered as typical values.

I_{peak} values [kA]

I_{cc} [kA]	I_n [A]															
	0.5	1	1.6	2	3	4	6	8	10	16	20	25	32	40	50	63
1	0.8	0.9	1.0	1.1	1.1	1.2	1.2	1.5	1.5	1.5	1.5	1.5	1.6	1.6	1.8	1.8
2	0.9	1.1	1.4	1.5	1.6	1.7	1.9	2.3	2.4	2.5	2.5	2.6	2.6	2.6	3.3	3.3
5	1.1	1.3	1.9	2.1	2.4	2.7	3.1	3.7	4.1	4.3	4.4	4.6	4.7	4.7	5.7	5.9
10	1.1	1.4	2.2	2.6	3.1	3.5	4.2	5.0	5.7	6.1	6.4	6.6	6.9	7.1	7.6	8.2

Miniature Circuit Breaker ST 200 M

I^2t values

ST 200 M B- and C-Characteristic
230/400 V AC let-through energy

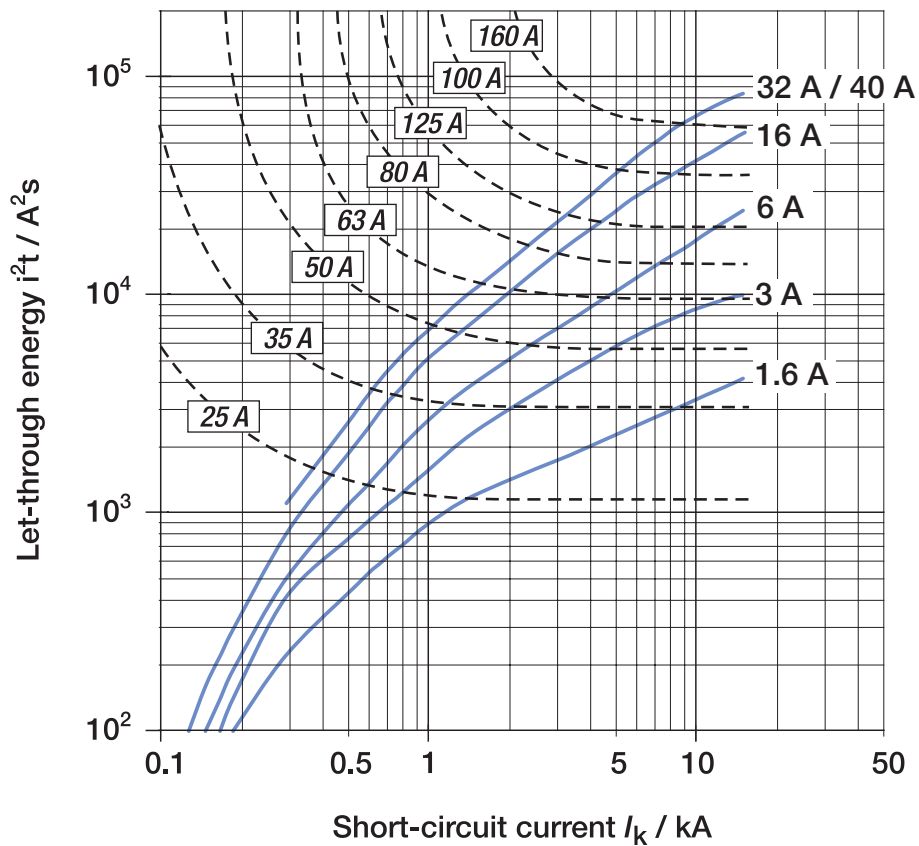
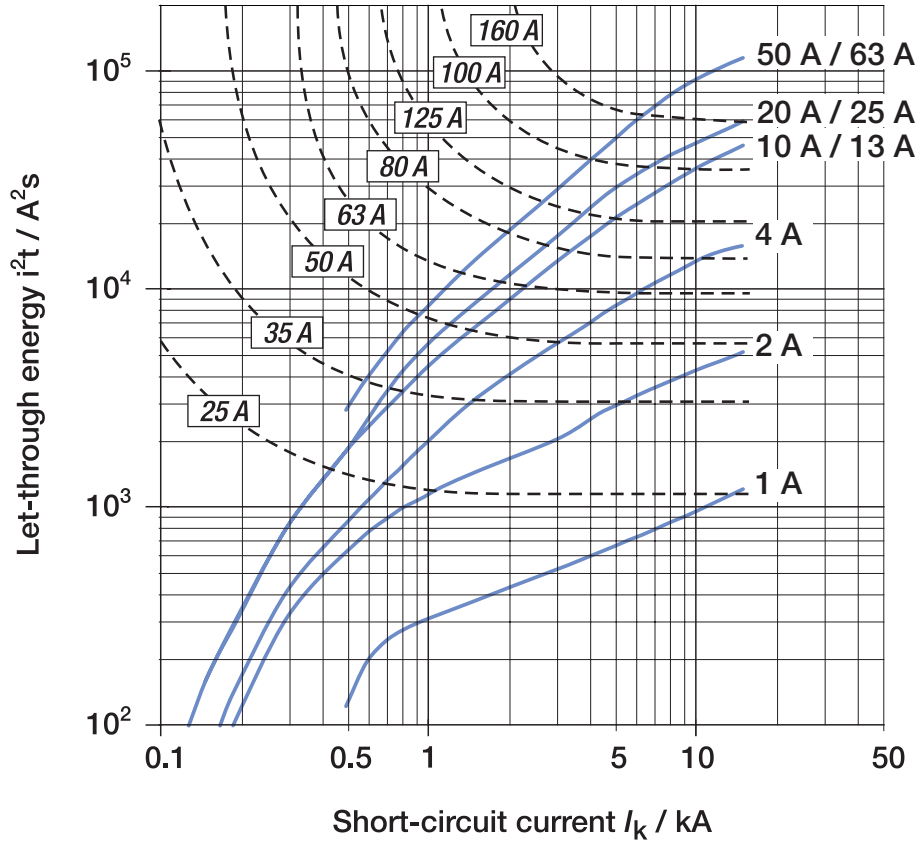

Miniature Circuit Breaker ST 200 M

I^2t values

ST 200 M Z-Characteristic

230/400 V AC let-through energy

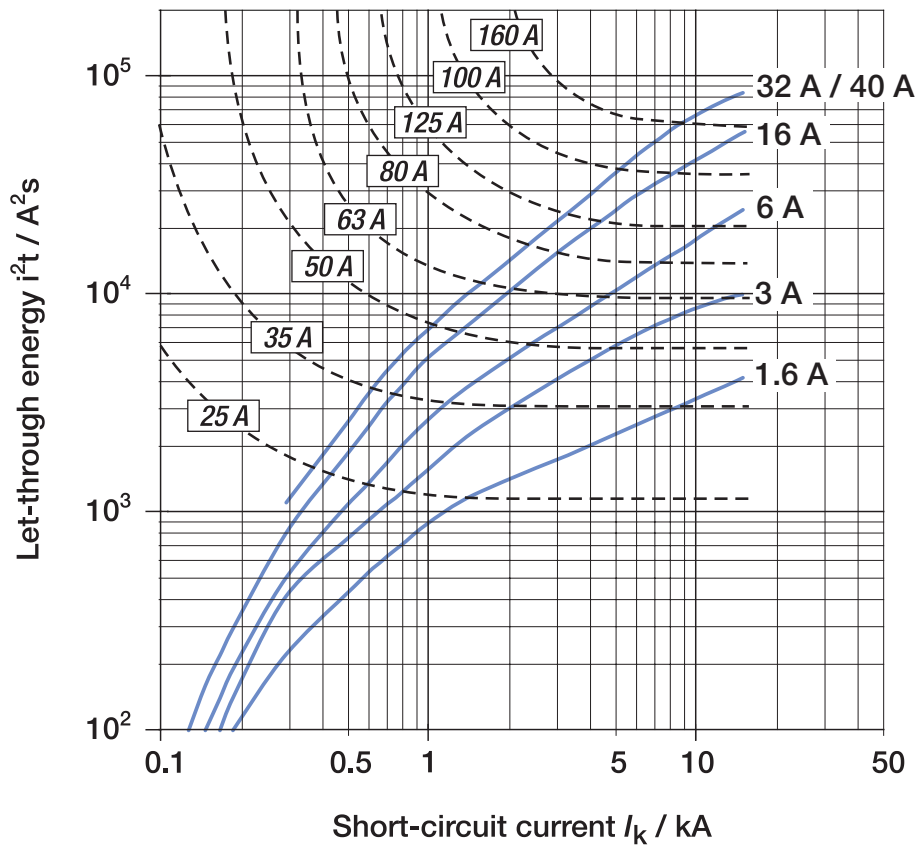
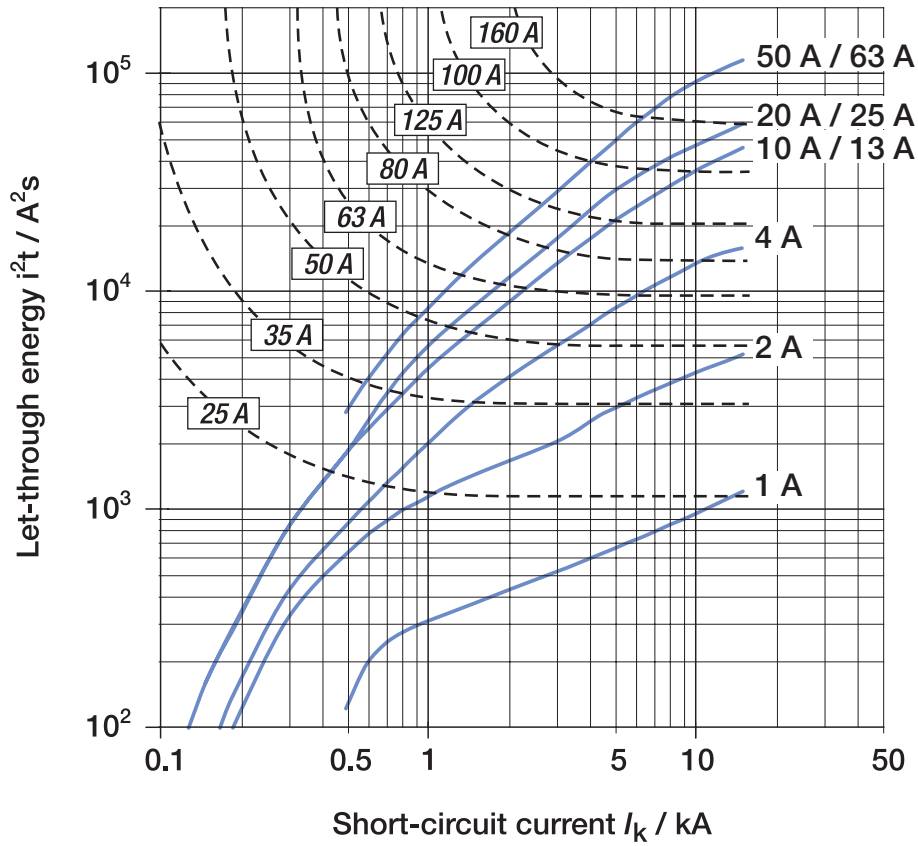

Miniature Circuit Breaker ST 200 M

I^2t values

ST 200 M D- and K-Characteristic
230/400 V AC let-through energy

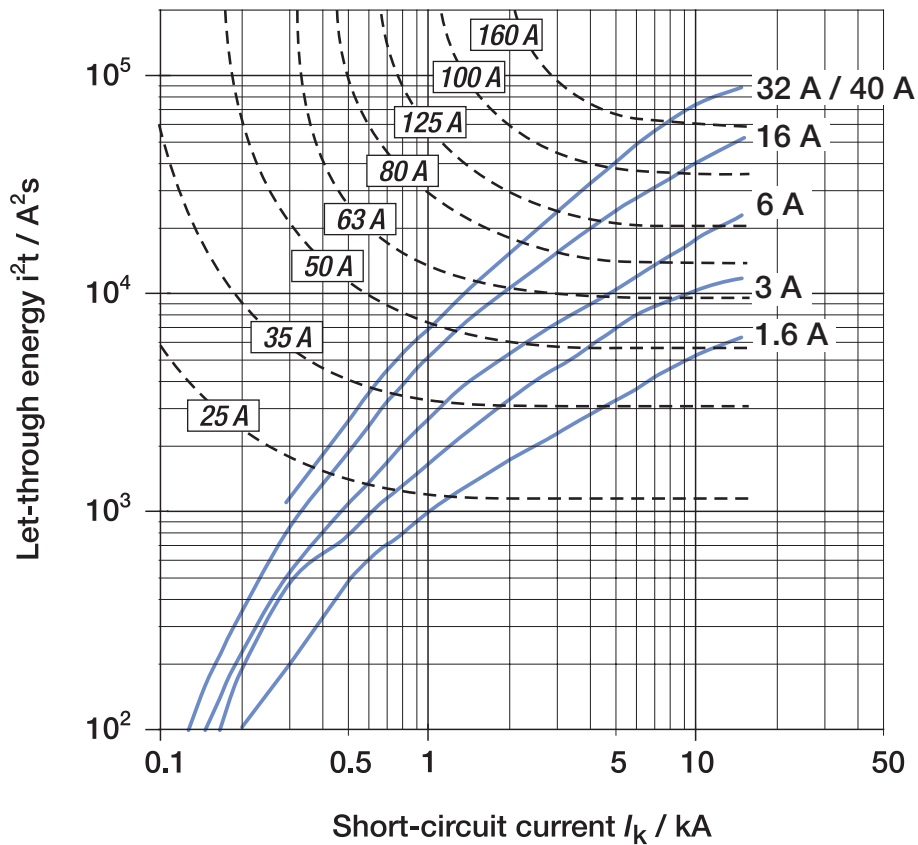
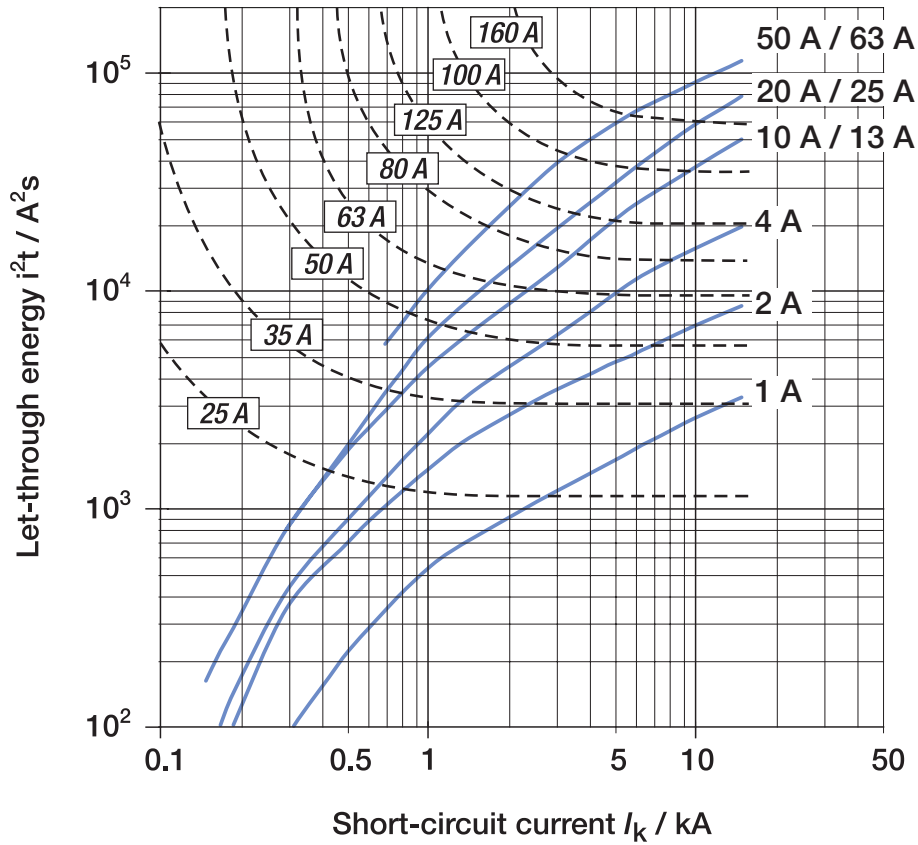

Miniature Circuit Breaker ST 200 M

Accessory overview and dimensional drawing

- H:**
Auxiliary contact (S2C-H6R)
- H-R:**
Auxiliary contact (S2C-H6-...R)
- S/H:**
Signal/Auxiliary contact (S2C-S/H6R)
- S/H (H):**
Signal/Auxiliary contact used as auxiliary contact (S2C-S/H6R)
- ST:**
Shunt trip for S 200 MCB (S2C-A...)
- UR:**
Undervoltage release (S2C-UA)
- OR:**
Overvoltage release (S2C-OVP)
- H-BF:**
Auxiliary contact for MCBs bottom fitting (1 for each pole of MCB) (S2C-H01/S2C-H10)
- BP:**
Mechanical tripping device (S2C-BP)

The certification of the accessories has been done with one accessory only. The number of electrical operations is limited to 4,000 operations for the maximum combinations and the combinations including shunt trips.

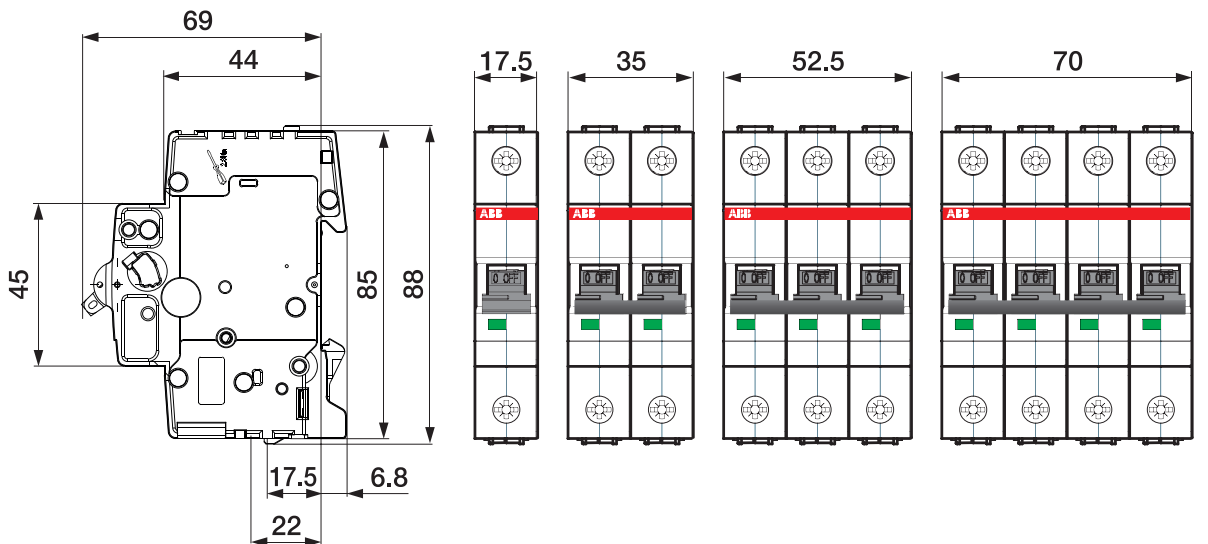
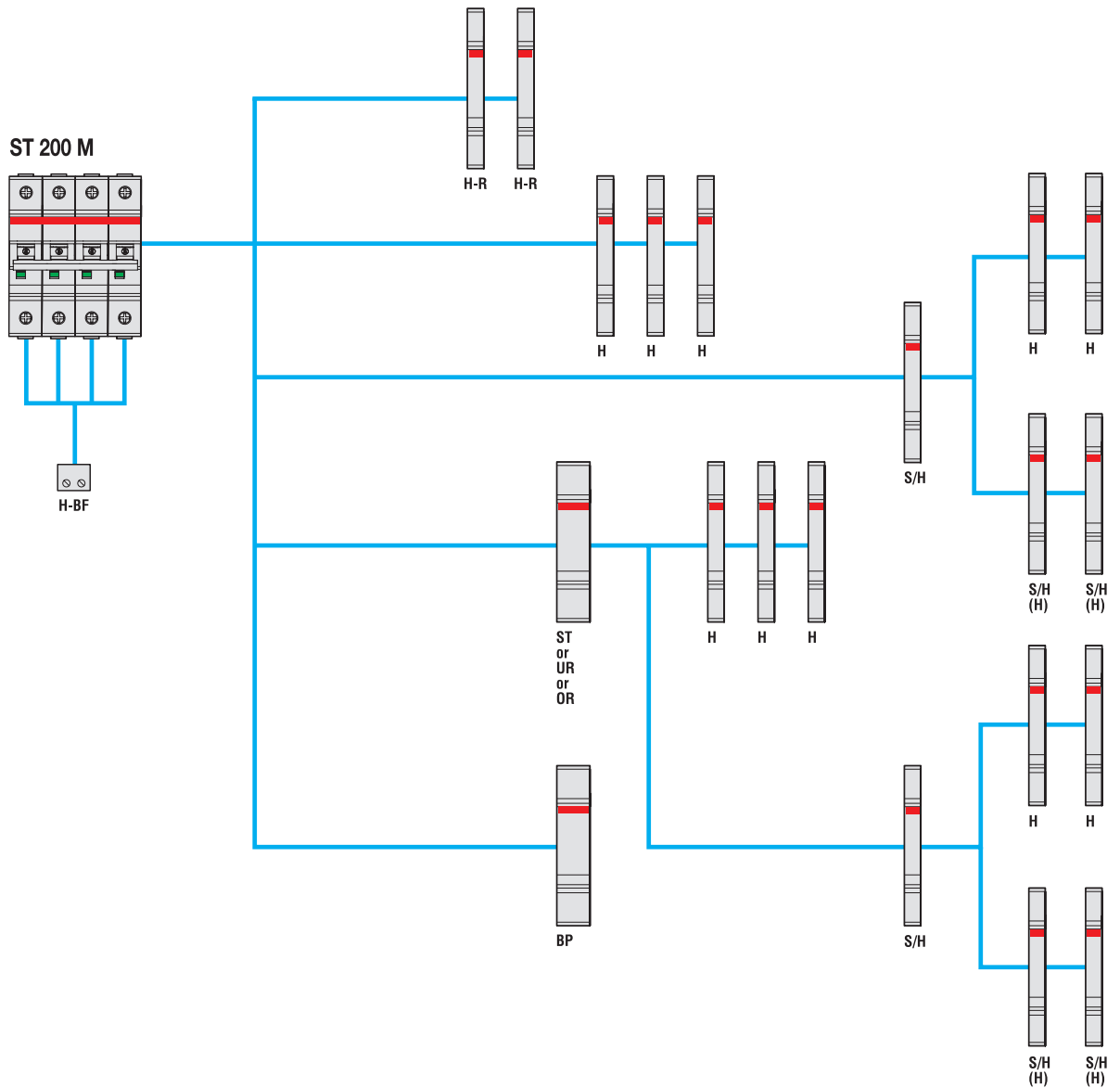

Miniature Circuit Breaker ST 200 M

Ordering data characteristic B



Number of poles	Rated current I _n [A]	Type code	Order code	Weight per PCE [kg]	Packing unit [PCE]
1	0.5	ST201M-B0,5	2CDS271334R0985	0.115	10
	1.6	ST201M-B1,6	2CDS271334R0975	0.115	10
	1	ST201M-B1	2CDS271334R0015	0.115	10
	2	ST201M-B2	2CDS271334R0025	0.115	10
	3	ST201M-B3	2CDS271334R0035	0.115	10
	4	ST201M-B4	2CDS271334R0045	0.115	10
	5	ST201M-B5	2CDS271334R0055	0.115	10
	6	ST201M-B6	2CDS271334R0065	0.115	10
	7	ST201M-B7	2CDS271334R0075	0.115	10
	8	ST201M-B8	2CDS271334R0085	0.115	10
	10	ST201M-B10	2CDS271334R0105	0.115	10
	13	ST201M-B13	2CDS271334R0135	0.115	10
	15	ST201M-B15	2CDS271334R0155	0.115	10
	16	ST201M-B16	2CDS271334R0165	0.115	10
	20	ST201M-B20	2CDS271334R0205	0.115	10
	25	ST201M-B25	2CDS271334R0255	0.115	10
	30	ST201M-B30	2CDS271334R0305	0.115	10
	32	ST201M-B32	2CDS271334R0325	0.115	10
	35	ST201M-B35	2CDS271334R0355	0.115	10
	40	ST201M-B40	2CDS271334R0405	0.115	10
50	ST201M-B50	2CDS271334R0505	0.115	10	
60	ST201M-B60	2CDS271334R0605	0.115	10	
63	ST201M-B63	2CDS271334R0635	0.115	10	
1+N	0.5	ST201M-B1,6NA	2CDS271335R0975	0.230	5
	1.6	ST201M-B0,5NA	2CDS271335R0985	0.230	5
	1	ST201M-B1NA	2CDS271335R0015	0.230	5
	2	ST201M-B2NA	2CDS271335R0025	0.230	5
	3	ST201M-B3NA	2CDS271335R0035	0.230	5
	4	ST201M-B4NA	2CDS271335R0045	0.230	5
	5	ST201M-B5NA	2CDS271335R0055	0.230	5
	6	ST201M-B6NA	2CDS271335R0065	0.230	5
	7	ST201M-B7NA	2CDS271335R0075	0.230	5
	8	ST201M-B8NA	2CDS271335R0085	0.230	5
	10	ST201M-B10NA	2CDS271335R0105	0.230	5
	13	ST201M-B13NA	2CDS271335R0135	0.230	5
	15	ST201M-B15NA	2CDS271335R0155	0.230	5
	16	ST201M-B16NA	2CDS271335R0165	0.230	5
	20	ST201M-B20NA	2CDS271335R0205	0.230	5
	25	ST201M-B25NA	2CDS271335R0255	0.230	5
	30	ST201M-B30NA	2CDS271335R0305	0.230	5
	32	ST201M-B32NA	2CDS271335R0325	0.230	5
	35	ST201M-B35NA	2CDS271335R0355	0.230	5
	40	ST201M-B40NA	2CDS271335R0405	0.230	5
50	ST201M-B50NA	2CDS271335R0505	0.230	5	
60	ST201M-B60NA	2CDS271335R0605	0.230	5	
63	ST201M-B63NA	2CDS271335R0635	0.230	5	
2	0.5	ST202M-B0,5	2CDS272334R0985	0.230	5
	1.6	ST202M-B1,6	2CDS272334R0975	0.230	5
	1	ST202M-B1	2CDS272334R0015	0.230	5
	2	ST202M-B2	2CDS272334R0025	0.230	5
	3	ST202M-B3	2CDS272334R0035	0.230	5
	4	ST202M-B4	2CDS272334R0045	0.230	5
	5	ST202M-B5	2CDS272334R0055	0.230	5
	6	ST202M-B6	2CDS272334R0065	0.230	5
	7	ST202M-B7	2CDS272334R0075	0.230	5
	8	ST202M-B8	2CDS272334R0085	0.230	5
	10	ST202M-B10	2CDS272334R0105	0.230	5
	13	ST202M-B13	2CDS272334R0135	0.230	5
	15	ST202M-B15	2CDS272334R0155	0.230	5
	16	ST202M-B16	2CDS272334R0165	0.230	5
	20	ST202M-B20	2CDS272334R0205	0.230	5
	25	ST202M-B25	2CDS272334R0255	0.230	5
	30	ST202M-B30	2CDS272334R0305	0.230	5
	32	ST202M-B32	2CDS272334R0325	0.230	5
	35	ST202M-B35	2CDS272334R0355	0.230	5
	40	ST202M-B40	2CDS272334R0405	0.230	5
50	ST202M-B50	2CDS272334R0505	0.230	5	
60	ST202M-B60	2CDS272334R0605	0.230	5	
63	ST202M-B63	2CDS272334R0635	0.230	5	

Miniature Circuit Breaker ST 200 M

Ordering data characteristic B



Number of poles	Rated current I _n [A]	Type code	Order code	Weight per PCE [kg]	Packing unit [PCE]
3	0.5	ST203M-B0,5	2CDS273334R0985	0.345	1
	1.6	ST203M-B1,6	2CDS273334R0975	0.345	1
	1	ST203M-B1	2CDS273334R0015	0.345	1
	2	ST203M-B2	2CDS273334R0025	0.345	1
	3	ST203M-B3	2CDS273334R0035	0.345	1
	4	ST203M-B4	2CDS273334R0045	0.345	1
	5	ST203M-B5	2CDS273334R0055	0.345	1
	6	ST203M-B6	2CDS273334R0065	0.345	1
	7	ST203M-B7	2CDS273334R0075	0.345	1
	8	ST203M-B8	2CDS273334R0085	0.345	1
	10	ST203M-B10	2CDS273334R0105	0.345	1
	13	ST203M-B13	2CDS273334R0135	0.345	1
	15	ST203M-B15	2CDS273334R0155	0.345	1
	16	ST203M-B16	2CDS273334R0165	0.345	1
	20	ST203M-B20	2CDS273334R0205	0.345	1
	25	ST203M-B25	2CDS273334R0255	0.345	1
	30	ST203M-B30	2CDS273334R0305	0.345	1
	32	ST203M-B32	2CDS273334R0325	0.345	1
	35	ST203M-B35	2CDS273334R0355	0.345	1
	40	ST203M-B40	2CDS273334R0405	0.345	1
50	ST203M-B50	2CDS273334R0505	0.345	1	
60	ST203M-B60	2CDS273334R0605	0.345	1	
63	ST203M-B63	2CDS273334R0635	0.345	1	
3+N	0.5	ST203M-B1,6NA	2CDS273335R0975	0.460	1
	1.6	ST203M-B0,5NA	2CDS273335R0985	0.460	1
	1	ST203M-B1NA	2CDS273335R0015	0.460	1
	2	ST203M-B2NA	2CDS273335R0025	0.460	1
	3	ST203M-B3NA	2CDS273335R0035	0.460	1
	4	ST203M-B4NA	2CDS273335R0045	0.460	1
	5	ST203M-B5NA	2CDS273335R0055	0.460	1
	6	ST203M-B6NA	2CDS273335R0065	0.460	1
	7	ST203M-B7NA	2CDS273335R0075	0.460	1
	8	ST203M-B8NA	2CDS273335R0085	0.460	1
	10	ST203M-B10NA	2CDS273335R0105	0.460	1
	13	ST203M-B13NA	2CDS273335R0135	0.460	1
	15	ST203M-B15NA	2CDS273335R0155	0.460	1
	16	ST203M-B16NA	2CDS273335R0165	0.460	1
	20	ST203M-B20NA	2CDS273335R0205	0.460	1
	25	ST203M-B25NA	2CDS273335R0255	0.460	1
	30	ST203M-B30NA	2CDS273335R0305	0.460	1
	32	ST203M-B32NA	2CDS273335R0325	0.460	1
	35	ST203M-B35NA	2CDS273335R0355	0.460	1
	40	ST203M-B40NA	2CDS273335R0405	0.460	1
50	ST203M-B50NA	2CDS273335R0505	0.460	1	
60	ST203M-B60NA	2CDS273335R0605	0.460	1	
63	ST203M-B63NA	2CDS273335R0635	0.460	1	
4	0.5	ST204M-B0,5	2CDS274334R0985	0.460	1
	1.6	ST204M-B1,6	2CDS274334R0975	0.460	1
	1	ST204M-B1	2CDS274334R0015	0.460	1
	2	ST204M-B2	2CDS274334R0025	0.460	1
	3	ST204M-B3	2CDS274334R0035	0.460	1
	4	ST204M-B4	2CDS274334R0045	0.460	1
	5	ST204M-B5	2CDS274334R0055	0.460	1
	6	ST204M-B6	2CDS274334R0065	0.460	1
	7	ST204M-B7	2CDS274334R0075	0.460	1
	8	ST204M-B8	2CDS274334R0085	0.460	1
	10	ST204M-B10	2CDS274334R0105	0.460	1
	13	ST204M-B13	2CDS274334R0135	0.460	1
	15	ST204M-B15	2CDS274334R0155	0.460	1
	16	ST204M-B16	2CDS274334R0165	0.460	1
	20	ST204M-B20	2CDS274334R0205	0.460	1
	25	ST204M-B25	2CDS274334R0255	0.460	1
	30	ST204M-B30	2CDS274334R0305	0.460	1
	32	ST204M-B32	2CDS274334R0325	0.460	1
	35	ST204M-B35	2CDS274334R0355	0.460	1
	40	ST204M-B40	2CDS274334R0405	0.460	1
50	ST204M-B50	2CDS274334R0505	0.460	1	
60	ST204M-B60	2CDS274334R0605	0.460	1	
63	ST204M-B63	2CDS274334R0635	0.460	1	

Miniature Circuit Breaker ST 200 M

Ordering data characteristic C



Number of poles	Rated current I _n [A]	Type code	Order code	Weight per PCE [kg]	Packing unit [PCE]
1	0.5	ST201M-C0,5	2CDS271334R0984	0.115	10
	1.6	ST201M-C1,6	2CDS271334R0974	0.115	10
	1	ST201M-C1	2CDS271334R0014	0.115	10
	2	ST201M-C2	2CDS271334R0024	0.115	10
	3	ST201M-C3	2CDS271334R0034	0.115	10
	4	ST201M-C4	2CDS271334R0044	0.115	10
	5	ST201M-C5	2CDS271334R0054	0.115	10
	6	ST201M-C6	2CDS271334R0064	0.115	10
	7	ST201M-C7	2CDS271334R0074	0.115	10
	8	ST201M-C8	2CDS271334R0084	0.115	10
	10	ST201M-C10	2CDS271334R0104	0.115	10
	13	ST201M-C13	2CDS271334R0134	0.115	10
	15	ST201M-C15	2CDS271334R0154	0.115	10
	16	ST201M-C16	2CDS271334R0164	0.115	10
	20	ST201M-C20	2CDS271334R0204	0.115	10
	25	ST201M-C25	2CDS271334R0254	0.115	10
	30	ST201M-C30	2CDS271334R0304	0.115	10
	32	ST201M-C32	2CDS271334R0324	0.115	10
	35	ST201M-C35	2CDS271334R0354	0.115	10
	40	ST201M-C40	2CDS271334R0404	0.115	10
	50	ST201M-C50	2CDS271334R0504	0.115	10
	60	ST201M-C60	2CDS271334R0604	0.115	10
	63	ST201M-C63	2CDS271334R0634	0.115	10
1+N	0.5	ST201M-C1,6NA	2CDS271335R0974	0.230	5
	1.6	ST201M-C0,5NA	2CDS271335R0984	0.230	5
	1	ST201M-C1NA	2CDS271335R0014	0.230	5
	2	ST201M-C2NA	2CDS271335R0024	0.230	5
	3	ST201M-C3NA	2CDS271335R0034	0.230	5
	4	ST201M-C4NA	2CDS271335R0044	0.230	5
	5	ST201M-C5NA	2CDS271335R0054	0.230	5
	6	ST201M-C6NA	2CDS271335R0064	0.230	5
	7	ST201M-C7NA	2CDS271335R0074	0.230	5
	8	ST201M-C8NA	2CDS271335R0084	0.230	5
	10	ST201M-C10NA	2CDS271335R0104	0.230	5
	13	ST201M-C13NA	2CDS271335R0134	0.230	5
	15	ST201M-C15NA	2CDS271335R0154	0.230	5
	16	ST201M-C16NA	2CDS271335R0164	0.230	5
	20	ST201M-C20NA	2CDS271335R0204	0.230	5
	25	ST201M-C25NA	2CDS271335R0254	0.230	5
	30	ST201M-C30NA	2CDS271335R0304	0.230	5
	32	ST201M-C32NA	2CDS271335R0324	0.230	5
	35	ST201M-C35NA	2CDS271335R0354	0.230	5
	40	ST201M-C40NA	2CDS271335R0404	0.230	5
	50	ST201M-C50NA	2CDS271335R0504	0.230	5
	60	ST201M-C60NA	2CDS271335R0604	0.230	5
	63	ST201M-C63NA	2CDS271335R0634	0.230	5
2	0.5	ST202M-C0,5	2CDS272334R0984	0.230	5
	1.6	ST202M-C1,6	2CDS272334R0974	0.230	5
	1	ST202M-C1	2CDS272334R0014	0.230	5
	2	ST202M-C2	2CDS272334R0024	0.230	5
	3	ST202M-C3	2CDS272334R0034	0.230	5
	4	ST202M-C4	2CDS272334R0044	0.230	5
	5	ST202M-C5	2CDS272334R0054	0.230	5
	6	ST202M-C6	2CDS272334R0064	0.230	5
	7	ST202M-C7	2CDS272334R0074	0.230	5
	8	ST202M-C8	2CDS272334R0084	0.230	5
	10	ST202M-C10	2CDS272334R0104	0.230	5
	13	ST202M-C13	2CDS272334R0134	0.230	5
	15	ST202M-C15	2CDS272334R0154	0.230	5
	16	ST202M-C16	2CDS272334R0164	0.230	5
	20	ST202M-C20	2CDS272334R0204	0.230	5
	25	ST202M-C25	2CDS272334R0254	0.230	5
	30	ST202M-C30	2CDS272334R0304	0.230	5
	32	ST202M-C32	2CDS272334R0324	0.230	5
	35	ST202M-C35	2CDS272334R0354	0.230	5
	40	ST202M-C40	2CDS272334R0404	0.230	5
	50	ST202M-C50	2CDS272334R0504	0.230	5
	60	ST202M-C60	2CDS272334R0604	0.230	5
	63	ST202M-C63	2CDS272334R0634	0.230	5

Miniature Circuit Breaker ST 200 M

Ordering data characteristic C



Number of poles	Rated current I _n [A]	Type code	Order code	Weight per PCE [kg]	Packing unit [PCE]
3	0.5	ST203M-C0,5	2CDS273334R0984	0.345	1
	1.6	ST203M-C1,6	2CDS273334R0974	0.345	1
	1	ST203M-C1	2CDS273334R0014	0.345	1
	2	ST203M-C2	2CDS273334R0024	0.345	1
	3	ST203M-C3	2CDS273334R0034	0.345	1
	4	ST203M-C4	2CDS273334R0044	0.345	1
	5	ST203M-C5	2CDS273334R0054	0.345	1
	6	ST203M-C6	2CDS273334R0064	0.345	1
	7	ST203M-C7	2CDS273334R0074	0.345	1
	8	ST203M-C8	2CDS273334R0084	0.345	1
	10	ST203M-C10	2CDS273334R0104	0.345	1
	13	ST203M-C13	2CDS273334R0134	0.345	1
	15	ST203M-C15	2CDS273334R0154	0.345	1
	16	ST203M-C16	2CDS273334R0164	0.345	1
	20	ST203M-C20	2CDS273334R0204	0.345	1
	25	ST203M-C25	2CDS273334R0254	0.345	1
	30	ST203M-C30	2CDS273334R0304	0.345	1
	32	ST203M-C32	2CDS273334R0324	0.345	1
	35	ST203M-C35	2CDS273334R0354	0.345	1
	40	ST203M-C40	2CDS273334R0404	0.345	1
50	ST203M-C50	2CDS273334R0504	0.345	1	
60	ST203M-C60	2CDS273334R0604	0.345	1	
63	ST203M-C63	2CDS273334R0634	0.345	1	
3+N	0.5	ST203M-C1,6NA	2CDS273335R0974	0.460	1
	1.6	ST203M-C0,5NA	2CDS273335R0984	0.460	1
	1	ST203M-C1NA	2CDS273335R0014	0.460	1
	2	ST203M-C2NA	2CDS273335R0024	0.460	1
	3	ST203M-C3NA	2CDS273335R0034	0.460	1
	4	ST203M-C4NA	2CDS273335R0044	0.460	1
	5	ST203M-C5NA	2CDS273335R0054	0.460	1
	6	ST203M-C6NA	2CDS273335R0064	0.460	1
	7	ST203M-C7NA	2CDS273335R0074	0.460	1
	8	ST203M-C8NA	2CDS273335R0084	0.460	1
	10	ST203M-C10NA	2CDS273335R0104	0.460	1
	13	ST203M-C13NA	2CDS273335R0134	0.460	1
	15	ST203M-C15NA	2CDS273335R0154	0.460	1
	16	ST203M-C16NA	2CDS273335R0164	0.460	1
	20	ST203M-C20NA	2CDS273335R0204	0.460	1
	25	ST203M-C25NA	2CDS273335R0254	0.460	1
	30	ST203M-C30NA	2CDS273335R0304	0.460	1
	32	ST203M-C32NA	2CDS273335R0324	0.460	1
	35	ST203M-C35NA	2CDS273335R0354	0.460	1
	40	ST203M-C40NA	2CDS273335R0404	0.460	1
50	ST203M-C50NA	2CDS273335R0504	0.460	1	
60	ST203M-C60NA	2CDS273335R0604	0.460	1	
63	ST203M-C63NA	2CDS273335R0634	0.460	1	
4	0.5	ST204M-C0,5	2CDS274334R0984	0.460	1
	1.6	ST204M-C1,6	2CDS274334R0974	0.460	1
	1	ST204M-C1	2CDS274334R0014	0.460	1
	2	ST204M-C2	2CDS274334R0024	0.460	1
	3	ST204M-C3	2CDS274334R0034	0.460	1
	4	ST204M-C4	2CDS274334R0044	0.460	1
	5	ST204M-C5	2CDS274334R0054	0.460	1
	6	ST204M-C6	2CDS274334R0064	0.460	1
	7	ST204M-C7	2CDS274334R0074	0.460	1
	8	ST204M-C8	2CDS274334R0084	0.460	1
	10	ST204M-C10	2CDS274334R0104	0.460	1
	13	ST204M-C13	2CDS274334R0134	0.460	1
	15	ST204M-C15	2CDS274334R0154	0.460	1
	16	ST204M-C16	2CDS274334R0164	0.460	1
	20	ST204M-C20	2CDS274334R0204	0.460	1
	25	ST204M-C25	2CDS274334R0254	0.460	1
	30	ST204M-C30	2CDS274334R0304	0.460	1
	32	ST204M-C32	2CDS274334R0324	0.460	1
	35	ST204M-C35	2CDS274334R0354	0.460	1
	40	ST204M-C40	2CDS274334R0404	0.460	1
50	ST204M-C50	2CDS274334R0504	0.460	1	
60	ST204M-C60	2CDS274334R0604	0.460	1	
63	ST204M-C63	2CDS274334R0634	0.460	1	

Miniature Circuit Breaker ST 200 M

Ordering data characteristic D



Number of poles	Rated current I _n [A]	Type code	Order code	Weight per PCE [kg]	Packing unit [PCE]
1	0.5	ST201M-D0,5	2CDS271334R0981	0.115	10
	1.6	ST201M-D1,6	2CDS271334R0971	0.115	10
	1	ST201M-D1	2CDS271334R0011	0.115	10
	2	ST201M-D2	2CDS271334R0021	0.115	10
	3	ST201M-D3	2CDS271334R0031	0.115	10
	4	ST201M-D4	2CDS271334R0041	0.115	10
	5	ST201M-D5	2CDS271334R0051	0.115	10
	6	ST201M-D6	2CDS271334R0061	0.115	10
	7	ST201M-D7	2CDS271334R0071	0.115	10
	8	ST201M-D8	2CDS271334R0081	0.115	10
	10	ST201M-D10	2CDS271334R0101	0.115	10
	13	ST201M-D13	2CDS271334R0131	0.115	10
	15	ST201M-D15	2CDS271334R0151	0.115	10
	16	ST201M-D16	2CDS271334R0161	0.115	10
	20	ST201M-D20	2CDS271334R0201	0.115	10
	25	ST201M-D25	2CDS271334R0251	0.115	10
	30	ST201M-D30	2CDS271334R0301	0.115	10
	32	ST201M-D32	2CDS271334R0321	0.115	10
	35	ST201M-D35	2CDS271334R0351	0.115	10
	40	ST201M-D40	2CDS271334R0401	0.115	10
	50	ST201M-D50	2CDS271334R0501	0.115	10
60	ST201M-D60	2CDS271334R0601	0.115	10	
63	ST201M-D63	2CDS271334R0631	0.115	10	
1+N	0.5	ST201M-D1,6NA	2CDS271335R0971	0.230	5
	1.6	ST201M-D0,5NA	2CDS271335R0981	0.230	5
	1	ST201M-D1NA	2CDS271335R0011	0.230	5
	2	ST201M-D2NA	2CDS271335R0021	0.230	5
	3	ST201M-D3NA	2CDS271335R0031	0.230	5
	4	ST201M-D4NA	2CDS271335R0041	0.230	5
	5	ST201M-D5NA	2CDS271335R0051	0.230	5
	6	ST201M-D6NA	2CDS271335R0061	0.230	5
	7	ST201M-D7NA	2CDS271335R0071	0.230	5
	8	ST201M-D8NA	2CDS271335R0081	0.230	5
	10	ST201M-D10NA	2CDS271335R0101	0.230	5
	13	ST201M-D13NA	2CDS271335R0131	0.230	5
	15	ST201M-D15NA	2CDS271335R0151	0.230	5
	16	ST201M-D16NA	2CDS271335R0161	0.230	5
	20	ST201M-D20NA	2CDS271335R0201	0.230	5
	25	ST201M-D25NA	2CDS271335R0251	0.230	5
	30	ST201M-D30NA	2CDS271335R0301	0.230	5
	32	ST201M-D32NA	2CDS271335R0321	0.230	5
	35	ST201M-D35NA	2CDS271335R0351	0.230	5
	40	ST201M-D40NA	2CDS271335R0401	0.230	5
	50	ST201M-D50NA	2CDS271335R0501	0.230	5
60	ST201M-D60NA	2CDS271335R0601	0.230	5	
63	ST201M-D63NA	2CDS271335R0631	0.230	5	
2	0.5	ST202M-D0,5	2CDS272334R0981	0.230	5
	1.6	ST202M-D1,6	2CDS272334R0971	0.230	5
	1	ST202M-D1	2CDS272334R0011	0.230	5
	2	ST202M-D2	2CDS272334R0021	0.230	5
	3	ST202M-D3	2CDS272334R0031	0.230	5
	4	ST202M-D4	2CDS272334R0041	0.230	5
	5	ST202M-D5	2CDS272334R0051	0.230	5
	6	ST202M-D6	2CDS272334R0061	0.230	5
	7	ST202M-D7	2CDS272334R0071	0.230	5
	8	ST202M-D8	2CDS272334R0081	0.230	5
	10	ST202M-D10	2CDS272334R0101	0.230	5
	13	ST202M-D13	2CDS272334R0131	0.230	5
	15	ST202M-D15	2CDS272334R0151	0.230	5
	16	ST202M-D16	2CDS272334R0161	0.230	5
	20	ST202M-D20	2CDS272334R0201	0.230	5
	25	ST202M-D25	2CDS272334R0251	0.230	5
	30	ST202M-D30	2CDS272334R0301	0.230	5
	32	ST202M-D32	2CDS272334R0321	0.230	5
	35	ST202M-D35	2CDS272334R0351	0.230	5
	40	ST202M-D40	2CDS272334R0401	0.230	5
	50	ST202M-D50	2CDS272334R0501	0.230	5
60	ST202M-D60	2CDS272334R0601	0.230	5	
63	ST202M-D63	2CDS272334R0631	0.230	5	

Miniature Circuit Breaker ST 200 M

Ordering data characteristic D



Number of poles	Rated current I _n [A]	Type code	Order code	Weight per PCE [kg]	Packing unit [PCE]
3	0.5	ST203M-D0,5	2CDS273334R0981	0.345	1
	1.6	ST203M-D1,6	2CDS273334R0971	0.345	1
	1	ST203M-D1	2CDS273334R0011	0.345	1
	2	ST203M-D2	2CDS273334R0021	0.345	1
	3	ST203M-D3	2CDS273334R0031	0.345	1
	4	ST203M-D4	2CDS273334R0041	0.345	1
	5	ST203M-D5	2CDS273334R0051	0.345	1
	6	ST203M-D6	2CDS273334R0061	0.345	1
	7	ST203M-D7	2CDS273334R0071	0.345	1
	8	ST203M-D8	2CDS273334R0081	0.345	1
	10	ST203M-D10	2CDS273334R0101	0.345	1
	13	ST203M-D13	2CDS273334R0131	0.345	1
	15	ST203M-D15	2CDS273334R0151	0.345	1
	16	ST203M-D16	2CDS273334R0161	0.345	1
	20	ST203M-D20	2CDS273334R0201	0.345	1
	25	ST203M-D25	2CDS273334R0251	0.345	1
	30	ST203M-D30	2CDS273334R0301	0.345	1
	32	ST203M-D32	2CDS273334R0321	0.345	1
	35	ST203M-D35	2CDS273334R0351	0.345	1
	40	ST203M-D40	2CDS273334R0401	0.345	1
50	ST203M-D50	2CDS273334R0501	0.345	1	
60	ST203M-D60	2CDS273334R0601	0.345	1	
63	ST203M-D63	2CDS273334R0631	0.345	1	
3+N	0.5	ST203M-D1,6NA	2CDS273335R0971	0.460	1
	1.6	ST203M-D0,5NA	2CDS273335R0981	0.460	1
	1	ST203M-D1NA	2CDS273335R0011	0.460	1
	2	ST203M-D2NA	2CDS273335R0021	0.460	1
	3	ST203M-D3NA	2CDS273335R0031	0.460	1
	4	ST203M-D4NA	2CDS273335R0041	0.460	1
	5	ST203M-D5NA	2CDS273335R0051	0.460	1
	6	ST203M-D6NA	2CDS273335R0061	0.460	1
	7	ST203M-D7NA	2CDS273335R0071	0.460	1
	8	ST203M-D8NA	2CDS273335R0081	0.460	1
	10	ST203M-D10NA	2CDS273335R0101	0.460	1
	13	ST203M-D13NA	2CDS273335R0131	0.460	1
	15	ST203M-D15NA	2CDS273335R0151	0.460	1
	16	ST203M-D16NA	2CDS273335R0161	0.460	1
	20	ST203M-D20NA	2CDS273335R0201	0.460	1
	25	ST203M-D25NA	2CDS273335R0251	0.460	1
	30	ST203M-D30NA	2CDS273335R0301	0.460	1
	32	ST203M-D32NA	2CDS273335R0321	0.460	1
	35	ST203M-D35NA	2CDS273335R0351	0.460	1
	40	ST203M-D40NA	2CDS273335R0401	0.460	1
50	ST203M-D50NA	2CDS273335R0501	0.460	1	
60	ST203M-D60NA	2CDS273335R0601	0.460	1	
63	ST203M-D63NA	2CDS273335R0631	0.460	1	
4	0.5	ST204M-D0,5	2CDS274334R0981	0.460	1
	1.6	ST204M-D1,6	2CDS274334R0971	0.460	1
	1	ST204M-D1	2CDS274334R0011	0.460	1
	2	ST204M-D2	2CDS274334R0021	0.460	1
	3	ST204M-D3	2CDS274334R0031	0.460	1
	4	ST204M-D4	2CDS274334R0041	0.460	1
	5	ST204M-D5	2CDS274334R0051	0.460	1
	6	ST204M-D6	2CDS274334R0061	0.460	1
	7	ST204M-D7	2CDS274334R0071	0.460	1
	8	ST204M-D8	2CDS274334R0081	0.460	1
	10	ST204M-D10	2CDS274334R0101	0.460	1
	13	ST204M-D13	2CDS274334R0131	0.460	1
	15	ST204M-D15	2CDS274334R0151	0.460	1
	16	ST204M-D16	2CDS274334R0161	0.460	1
	20	ST204M-D20	2CDS274334R0201	0.460	1
	25	ST204M-D25	2CDS274334R0251	0.460	1
	30	ST204M-D30	2CDS274334R0301	0.460	1
	32	ST204M-D32	2CDS274334R0321	0.460	1
	35	ST204M-D35	2CDS274334R0351	0.460	1
	40	ST204M-D40	2CDS274334R0401	0.460	1
50	ST204M-D50	2CDS274334R0501	0.460	1	
60	ST204M-D60	2CDS274334R0601	0.460	1	
63	ST204M-D63	2CDS274334R0631	0.460	1	

Miniature Circuit Breaker ST 200 M

Ordering data characteristic K



Number of poles	Rated current I _n [A]	Type code	Order code	Weight per PCE [kg]	Packing unit [PCE]
1	0.5	ST201M-K0,5	2CDS271334R0157	0.115	10
	1.6	ST201M-K1,6	2CDS271334R0257	0.115	10
	1	ST201M-K1	2CDS271334R0217	0.115	10
	2	ST201M-K2	2CDS271334R0277	0.115	10
	3	ST201M-K3	2CDS271334R0317	0.115	10
	4	ST201M-K4	2CDS271334R0337	0.115	10
	5	ST201M-K5	2CDS271334R0357	0.115	10
	6	ST201M-K6	2CDS271334R0377	0.115	10
	7	ST201M-K7	2CDS271334R0387	0.115	10
	8	ST201M-K8	2CDS271334R0407	0.115	10
	10	ST201M-K10	2CDS271334R0427	0.115	10
	13	ST201M-K13	2CDS271334R0447	0.115	10
	15	ST201M-K15	2CDS271334R0457	0.115	10
	16	ST201M-K16	2CDS271334R0467	0.115	10
	20	ST201M-K20	2CDS271334R0487	0.115	10
	25	ST201M-K25	2CDS271334R0517	0.115	10
	30	ST201M-K30	2CDS271334R0527	0.115	10
	32	ST201M-K32	2CDS271334R0537	0.115	10
	35	ST201M-K35	2CDS271334R0547	0.115	10
	40	ST201M-K40	2CDS271334R0557	0.115	10
50	ST201M-K50	2CDS271334R0577	0.115	10	
60	ST201M-K60	2CDS271334R0587	0.115	10	
63	ST201M-K63	2CDS271334R0607	0.115	10	
1+N	0.5	ST201M-K1,6NA	2CDS271335R0257	0.230	5
	1.6	ST201M-K0,5NA	2CDS271335R0157	0.230	5
	1	ST201M-K1NA	2CDS271335R0217	0.230	5
	2	ST201M-K2NA	2CDS271335R0277	0.230	5
	3	ST201M-K3NA	2CDS271335R0317	0.230	5
	4	ST201M-K4NA	2CDS271335R0337	0.230	5
	5	ST201M-K5NA	2CDS271335R0357	0.230	5
	6	ST201M-K6NA	2CDS271335R0377	0.230	5
	7	ST201M-K7NA	2CDS271335R0387	0.230	5
	8	ST201M-K8NA	2CDS271335R0407	0.230	5
	10	ST201M-K10NA	2CDS271335R0427	0.230	5
	13	ST201M-K13NA	2CDS271335R0447	0.230	5
	15	ST201M-K15NA	2CDS271335R0457	0.230	5
	16	ST201M-K16NA	2CDS271335R0467	0.230	5
	20	ST201M-K20NA	2CDS271335R0487	0.230	5
	25	ST201M-K25NA	2CDS271335R0517	0.230	5
	30	ST201M-K30NA	2CDS271335R0527	0.230	5
	32	ST201M-K32NA	2CDS271335R0537	0.230	5
	35	ST201M-K35NA	2CDS271335R0547	0.230	5
	40	ST201M-K40NA	2CDS271335R0557	0.230	5
50	ST201M-K50NA	2CDS271335R0577	0.230	5	
60	ST201M-K60NA	2CDS271335R0587	0.230	5	
63	ST201M-K63NA	2CDS271335R0607	0.230	5	
2	0.5	ST202M-K0,5	2CDS272334R0157	0.230	5
	1.6	ST202M-K1,6	2CDS272334R0257	0.230	5
	1	ST202M-K1	2CDS272334R0217	0.230	5
	2	ST202M-K2	2CDS272334R0277	0.230	5
	3	ST202M-K3	2CDS272334R0317	0.230	5
	4	ST202M-K4	2CDS272334R0337	0.230	5
	5	ST202M-K5	2CDS272334R0357	0.230	5
	6	ST202M-K6	2CDS272334R0377	0.230	5
	7	ST202M-K7	2CDS272334R0387	0.230	5
	8	ST202M-K8	2CDS272334R0407	0.230	5
	10	ST202M-K10	2CDS272334R0427	0.230	5
	13	ST202M-K13	2CDS272334R0447	0.230	5
	15	ST202M-K15	2CDS272334R0457	0.230	5
	16	ST202M-K16	2CDS272334R0467	0.230	5
	20	ST202M-K20	2CDS272334R0487	0.230	5
	25	ST202M-K25	2CDS272334R0517	0.230	5
	30	ST202M-K30	2CDS272334R0527	0.230	5
	32	ST202M-K32	2CDS272334R0537	0.230	5
	35	ST202M-K35	2CDS272334R0547	0.230	5
	40	ST202M-K40	2CDS272334R0557	0.230	5
50	ST202M-K50	2CDS272334R0577	0.230	5	
60	ST202M-K60	2CDS272334R0587	0.230	5	
63	ST202M-K63	2CDS272334R0607	0.230	5	

Miniature Circuit Breaker ST 200 M

Ordering data characteristic K



Number of poles	Rated current I _n [A]	Type code	Order code	Weight per PCE [kg]	Packing unit [PCE]
3	0.5	ST203M-K0,5	2CDS273334R0157	0.345	1
	1.6	ST203M-K1,6	2CDS273334R0257	0.345	1
	1	ST203M-K1	2CDS273334R0217	0.345	1
	2	ST203M-K2	2CDS273334R0277	0.345	1
	3	ST203M-K3	2CDS273334R0317	0.345	1
	4	ST203M-K4	2CDS273334R0337	0.345	1
	5	ST203M-K5	2CDS273334R0357	0.345	1
	6	ST203M-K6	2CDS273334R0377	0.345	1
	7	ST203M-K7	2CDS273334R0387	0.345	1
	8	ST203M-K8	2CDS273334R0407	0.345	1
	10	ST203M-K10	2CDS273334R0427	0.345	1
	13	ST203M-K13	2CDS273334R0447	0.345	1
	15	ST203M-K15	2CDS273334R0457	0.345	1
	16	ST203M-K16	2CDS273334R0467	0.345	1
	20	ST203M-K20	2CDS273334R0487	0.345	1
	25	ST203M-K25	2CDS273334R0517	0.345	1
	30	ST203M-K30	2CDS273334R0527	0.345	1
	32	ST203M-K32	2CDS273334R0537	0.345	1
	35	ST203M-K35	2CDS273334R0547	0.345	1
	40	ST203M-K40	2CDS273334R0557	0.345	1
50	ST203M-K50	2CDS273334R0577	0.345	1	
60	ST203M-K60	2CDS273334R0587	0.345	1	
63	ST203M-K63	2CDS273334R0607	0.345	1	
3+N	0.5	ST203M-K1,6NA	2CDS273335R0257	0.460	1
	1.6	ST203M-K0,5NA	2CDS273335R0157	0.460	1
	1	ST203M-K1NA	2CDS273335R0217	0.460	1
	2	ST203M-K2NA	2CDS273335R0277	0.460	1
	3	ST203M-K3NA	2CDS273335R0317	0.460	1
	4	ST203M-K4NA	2CDS273335R0337	0.460	1
	5	ST203M-K5NA	2CDS273335R0357	0.460	1
	6	ST203M-K6NA	2CDS273335R0377	0.460	1
	7	ST203M-K7NA	2CDS273335R0387	0.460	1
	8	ST203M-K8NA	2CDS273335R0407	0.460	1
	10	ST203M-K10NA	2CDS273335R0427	0.460	1
	13	ST203M-K13NA	2CDS273335R0447	0.460	1
	15	ST203M-K15NA	2CDS273335R0457	0.460	1
	16	ST203M-K16NA	2CDS273335R0467	0.460	1
	20	ST203M-K20NA	2CDS273335R0487	0.460	1
	25	ST203M-K25NA	2CDS273335R0517	0.460	1
	30	ST203M-K30NA	2CDS273335R0527	0.460	1
	32	ST203M-K32NA	2CDS273335R0537	0.460	1
	35	ST203M-K35NA	2CDS273335R0547	0.460	1
	40	ST203M-K40NA	2CDS273335R0557	0.460	1
50	ST203M-K50NA	2CDS273335R0577	0.460	1	
60	ST203M-K60NA	2CDS273335R0587	0.460	1	
63	ST203M-K63NA	2CDS273335R0607	0.460	1	
4	0.5	ST204M-K0,5	2CDS274334R0157	0.460	1
	1.6	ST204M-K1,6	2CDS274334R0257	0.460	1
	1	ST204M-K1	2CDS274334R0217	0.460	1
	2	ST204M-K2	2CDS274334R0277	0.460	1
	3	ST204M-K3	2CDS274334R0317	0.460	1
	4	ST204M-K4	2CDS274334R0337	0.460	1
	5	ST204M-K5	2CDS274334R0357	0.460	1
	6	ST204M-K6	2CDS274334R0377	0.460	1
	7	ST204M-K7	2CDS274334R0387	0.460	1
	8	ST204M-K8	2CDS274334R0407	0.460	1
	10	ST204M-K10	2CDS274334R0427	0.460	1
	13	ST204M-K13	2CDS274334R0447	0.460	1
	15	ST204M-K15	2CDS274334R0457	0.460	1
	16	ST204M-K16	2CDS274334R0467	0.460	1
	20	ST204M-K20	2CDS274334R0487	0.460	1
	25	ST204M-K25	2CDS274334R0517	0.460	1
	30	ST204M-K30	2CDS274334R0527	0.460	1
	32	ST204M-K32	2CDS274334R0537	0.460	1
	35	ST204M-K35	2CDS274334R0547	0.460	1
	40	ST204M-K40	2CDS274334R0557	0.460	1
50	ST204M-K50	2CDS274334R0577	0.460	1	
60	ST204M-K60	2CDS274334R0587	0.460	1	
63	ST204M-K63	2CDS274334R0607	0.460	1	

Miniature Circuit Breaker ST 200 M

Ordering data characteristic Z



Number of poles	Rated current I _n [A]	Type code	Order code	Weight per PCE [kg]	Packing unit [PCE]
1	0.5	ST201M-Z0,5	2CDS271334R0158	0.115	10
	1.6	ST201M-Z1,6	2CDS271334R0258	0.115	10
	1	ST201M-Z1	2CDS271334R0218	0.115	10
	2	ST201M-Z2	2CDS271334R0278	0.115	10
	3	ST201M-Z3	2CDS271334R0318	0.115	10
	4	ST201M-Z4	2CDS271334R0338	0.115	10
	5	ST201M-Z5	2CDS271334R0358	0.115	10
	6	ST201M-Z6	2CDS271334R0378	0.115	10
	7	ST201M-Z7	2CDS271334R0388	0.115	10
	8	ST201M-Z8	2CDS271334R0408	0.115	10
	10	ST201M-Z10	2CDS271334R0428	0.115	10
	13	ST201M-Z13	2CDS271334R0448	0.115	10
	15	ST201M-Z15	2CDS271334R0458	0.115	10
	16	ST201M-Z16	2CDS271334R0468	0.115	10
	20	ST201M-Z20	2CDS271334R0488	0.115	10
	25	ST201M-Z25	2CDS271334R0518	0.115	10
	30	ST201M-Z30	2CDS271334R0528	0.115	10
	32	ST201M-Z32	2CDS271334R0538	0.115	10
	35	ST201M-Z35	2CDS271334R0548	0.115	10
	40	ST201M-Z40	2CDS271334R0558	0.115	10
	50	ST201M-Z50	2CDS271334R0578	0.115	10
60	ST201M-Z60	2CDS271334R0588	0.115	10	
63	ST201M-Z63	2CDS271334R0608	0.115	10	
1+N	0.5	ST201M-Z1,6NA	2CDS271335R0258	0.230	5
	1.6	ST201M-Z0,5NA	2CDS271335R0158	0.230	5
	1	ST201M-Z1NA	2CDS271335R0218	0.230	5
	2	ST201M-Z2NA	2CDS271335R0278	0.230	5
	3	ST201M-Z3NA	2CDS271335R0318	0.230	5
	4	ST201M-Z4NA	2CDS271335R0338	0.230	5
	5	ST201M-Z5NA	2CDS271335R0358	0.230	5
	6	ST201M-Z6NA	2CDS271335R0378	0.230	5
	7	ST201M-Z7NA	2CDS271335R0388	0.230	5
	8	ST201M-Z8NA	2CDS271335R0408	0.230	5
	10	ST201M-Z10NA	2CDS271335R0428	0.230	5
	13	ST201M-Z13NA	2CDS271335R0448	0.230	5
	15	ST201M-Z15NA	2CDS271335R0458	0.230	5
	16	ST201M-Z16NA	2CDS271335R0468	0.230	5
	20	ST201M-Z20NA	2CDS271335R0488	0.230	5
	25	ST201M-Z25NA	2CDS271335R0518	0.230	5
	30	ST201M-Z30NA	2CDS271335R0528	0.230	5
	32	ST201M-Z32NA	2CDS271335R0538	0.230	5
	35	ST201M-Z35NA	2CDS271335R0548	0.230	5
	40	ST201M-Z40NA	2CDS271335R0558	0.230	5
	50	ST201M-Z50NA	2CDS271335R0578	0.230	5
60	ST201M-Z60NA	2CDS271335R0588	0.230	5	
63	ST201M-Z63NA	2CDS271335R0608	0.230	5	
2	0.5	ST202M-Z0,5	2CDS272334R0158	0.230	5
	1.6	ST202M-Z1,6	2CDS272334R0258	0.230	5
	1	ST202M-Z1	2CDS272334R0218	0.230	5
	2	ST202M-Z2	2CDS272334R0278	0.230	5
	3	ST202M-Z3	2CDS272334R0318	0.230	5
	4	ST202M-Z4	2CDS272334R0338	0.230	5
	5	ST202M-Z5	2CDS272334R0358	0.230	5
	6	ST202M-Z6	2CDS272334R0378	0.230	5
	7	ST202M-Z7	2CDS272334R0388	0.230	5
	8	ST202M-Z8	2CDS272334R0408	0.230	5
	10	ST202M-Z10	2CDS272334R0428	0.230	5
	13	ST202M-Z13	2CDS272334R0448	0.230	5
	15	ST202M-Z15	2CDS272334R0458	0.230	5
	16	ST202M-Z16	2CDS272334R0468	0.230	5
	20	ST202M-Z20	2CDS272334R0488	0.230	5
	25	ST202M-Z25	2CDS272334R0518	0.230	5
	30	ST202M-Z30	2CDS272334R0528	0.230	5
	32	ST202M-Z32	2CDS272334R0538	0.230	5
	35	ST202M-Z35	2CDS272334R0548	0.230	5
	40	ST202M-Z40	2CDS272334R0558	0.230	5
	50	ST202M-Z50	2CDS272334R0578	0.230	5
60	ST202M-Z60	2CDS272334R0588	0.230	5	
63	ST202M-Z63	2CDS272334R0608	0.230	5	

Miniature Circuit Breaker ST 200 M

Ordering data characteristic Z



Number of poles	Rated current I _n [A]	Type code	Order code	Weight per PCE [kg]	Packing unit [PCE]
3	0.5	ST203M-Z0,5	2CDS273334R0158	0.345	1
	1.6	ST203M-Z1,6	2CDS273334R0258	0.345	1
	1	ST203M-Z1	2CDS273334R0218	0.345	1
	2	ST203M-Z2	2CDS273334R0278	0.345	1
	3	ST203M-Z3	2CDS273334R0318	0.345	1
	4	ST203M-Z4	2CDS273334R0338	0.345	1
	5	ST203M-Z5	2CDS273334R0358	0.345	1
	6	ST203M-Z6	2CDS273334R0378	0.345	1
	7	ST203M-Z7	2CDS273334R0388	0.345	1
	8	ST203M-Z8	2CDS273334R0408	0.345	1
	10	ST203M-Z10	2CDS273334R0428	0.345	1
	13	ST203M-Z13	2CDS273334R0448	0.345	1
	15	ST203M-Z15	2CDS273334R0458	0.345	1
	16	ST203M-Z16	2CDS273334R0468	0.345	1
	20	ST203M-Z20	2CDS273334R0488	0.345	1
	25	ST203M-Z25	2CDS273334R0518	0.345	1
	30	ST203M-Z30	2CDS273334R0528	0.345	1
	32	ST203M-Z32	2CDS273334R0538	0.345	1
	35	ST203M-Z35	2CDS273334R0548	0.345	1
	40	ST203M-Z40	2CDS273334R0558	0.345	1
50	ST203M-Z50	2CDS273334R0578	0.345	1	
60	ST203M-Z60	2CDS273334R0588	0.345	1	
63	ST203M-Z63	2CDS273334R0608	0.345	1	
3+N	0.5	ST203M-Z1,6NA	2CDS273335R0258	0.460	1
	1.6	ST203M-Z0,5NA	2CDS273335R0158	0.460	1
	1	ST203M-Z1NA	2CDS273335R0218	0.460	1
	2	ST203M-Z2NA	2CDS273335R0278	0.460	1
	3	ST203M-Z3NA	2CDS273335R0318	0.460	1
	4	ST203M-Z4NA	2CDS273335R0338	0.460	1
	5	ST203M-Z5NA	2CDS273335R0358	0.460	1
	6	ST203M-Z6NA	2CDS273335R0378	0.460	1
	7	ST203M-Z7NA	2CDS273335R0388	0.460	1
	8	ST203M-Z8NA	2CDS273335R0408	0.460	1
	10	ST203M-Z10NA	2CDS273335R0428	0.460	1
	13	ST203M-Z13NA	2CDS273335R0448	0.460	1
	15	ST203M-Z15NA	2CDS273335R0458	0.460	1
	16	ST203M-Z16NA	2CDS273335R0468	0.460	1
	20	ST203M-Z20NA	2CDS273335R0488	0.460	1
	25	ST203M-Z25NA	2CDS273335R0518	0.460	1
	30	ST203M-Z30NA	2CDS273335R0528	0.460	1
	32	ST203M-Z32NA	2CDS273335R0538	0.460	1
	35	ST203M-Z35NA	2CDS273335R0548	0.460	1
	40	ST203M-Z40NA	2CDS273335R0558	0.460	1
50	ST203M-Z50NA	2CDS273335R0578	0.460	1	
60	ST203M-Z60NA	2CDS273335R0588	0.460	1	
63	ST203M-Z63NA	2CDS273335R0608	0.460	1	
4	0.5	ST204M-Z0,5	2CDS274334R0158	0.460	1
	1.6	ST204M-Z1,6	2CDS274334R0258	0.460	1
	1	ST204M-Z1	2CDS274334R0218	0.460	1
	2	ST204M-Z2	2CDS274334R0278	0.460	1
	3	ST204M-Z3	2CDS274334R0318	0.460	1
	4	ST204M-Z4	2CDS274334R0338	0.460	1
	5	ST204M-Z5	2CDS274334R0358	0.460	1
	6	ST204M-Z6	2CDS274334R0378	0.460	1
	7	ST204M-Z7	2CDS274334R0388	0.460	1
	8	ST204M-Z8	2CDS274334R0408	0.460	1
	10	ST204M-Z10	2CDS274334R0428	0.460	1
	13	ST204M-Z13	2CDS274334R0448	0.460	1
	15	ST204M-Z15	2CDS274334R0458	0.460	1
	16	ST204M-Z16	2CDS274334R0468	0.460	1
	20	ST204M-Z20	2CDS274334R0488	0.460	1
	25	ST204M-Z25	2CDS274334R0518	0.460	1
	30	ST204M-Z30	2CDS274334R0528	0.460	1
	32	ST204M-Z32	2CDS274334R0538	0.460	1
	35	ST204M-Z35	2CDS274334R0548	0.460	1
	40	ST204M-Z40	2CDS274334R0558	0.460	1
50	ST204M-Z50	2CDS274334R0578	0.460	1	
60	ST204M-Z60	2CDS274334R0588	0.460	1	
63	ST204M-Z63	2CDS274334R0608	0.460	1	